



## Air/Fuel Monitor

Nelson Riedel [nriedel@nextek.net](mailto:nriedel@nextek.net)  
draft revised 12-26-01

The primary function of the carburettor is to provide the correct air fuel mixture. Unfortunately us Triumph enthusiasts face some problems related to this function such as:

- The correct mixture depends on whether one is interested in economy or power.
- Even when one knows whether they want power or economy, it's difficult to tell how the carbs are actually performing.
- The mixture varies over the operating range of the carbs.

We are usually reduced to lifting carb air valves or checking spark plug color as a rough indication of carb mixture. I've often thought I'd like to have a mixture meter that would visually display the mixture as I drove the car. Once I knew the mixture, I figured I could then tune the carbs better and would know that I'm at peak performance (either power or economy). I figured such instruments are readily available but probably cost more than the car is worth.

Dick Taylor had mentioned from time to time that he uses an O2 sensor to tune carbs. I finally asked him for more information and he told me that he uses a K&N Air / Fuel Ratio Monitor that costs less than \$170. These monitors pictured below are available from [http://www.alamomotorsports.com/knn\\_afr.html](http://www.alamomotorsports.com/knn_afr.html). That is much less than I expected and well within my affordability (although the spouse would say \$170 is still more than my TR6 is worth).



Dick gave me some additional links that have more information and describe circuitry others have used to display the A/F readings. The following are some of these links.

- [http://www.pelicanparts.com/techarticles/mult\\_air\\_fuel\\_monitor/mult\\_air\\_fuel\\_monitor.htm](http://www.pelicanparts.com/techarticles/mult_air_fuel_monitor/mult_air_fuel_monitor.htm)
- <http://www.students.tut.fi/~eppu/dev/EGO-bar.html>
- <http://www.engr.ucdavis.edu/~avsmith/o2sensor.html>

I learned a lot about the oxygen sensors and how they can be used to measure the air/fuel (A/F) mixture from these articles.

**History:** I don't know the actual history but can guess at what happened. The auto industry had the oxygen sensor developed in the 1970s or 1980s. The sensor provided input to the electronic control systems used to regulate the mixture for both economy and emissions. Note that this is a closed loop system --- automatic control. Since the sensors were soon used on all autos, cost reductions ensued and the prices of sensors dropped.

Some knowledgeable people then probably applied the technology to build a monitor (an open loop system) to evaluate the performance of their earlier cars, possibly hi performance cars or race cars. The data on the links above indicate the engineering students/faculty were into these measurement systems in the 90s. By now, this stuff is probably old hat to the performance folks.

**The O<sub>2</sub> sensor:** The O<sub>2</sub> stands for the oxygen molecule, the predominate form of oxygen in the atmosphere. The O stands for the Oxygen atom and the 2 means two atoms per molecule.

The sensors are used to sense the amount of O<sub>2</sub> in the exhaust gases. Too little O<sub>2</sub> means that the mixture is too rich, too much O<sub>2</sub>, the mixture is too lean. The left graph below presents the relationship between A/F mixture, economy & power.

The ideal A/F mixture is 14.7 to 1 or 14.7:1 or simply 14.7. The ratio of the actual mixture to the ideal mixture is defined as Lambda, the excess air factor.

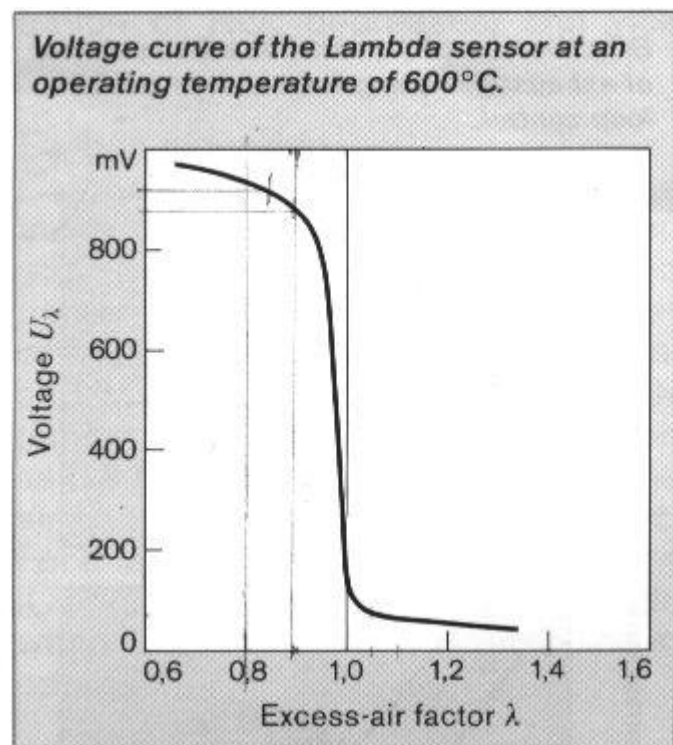
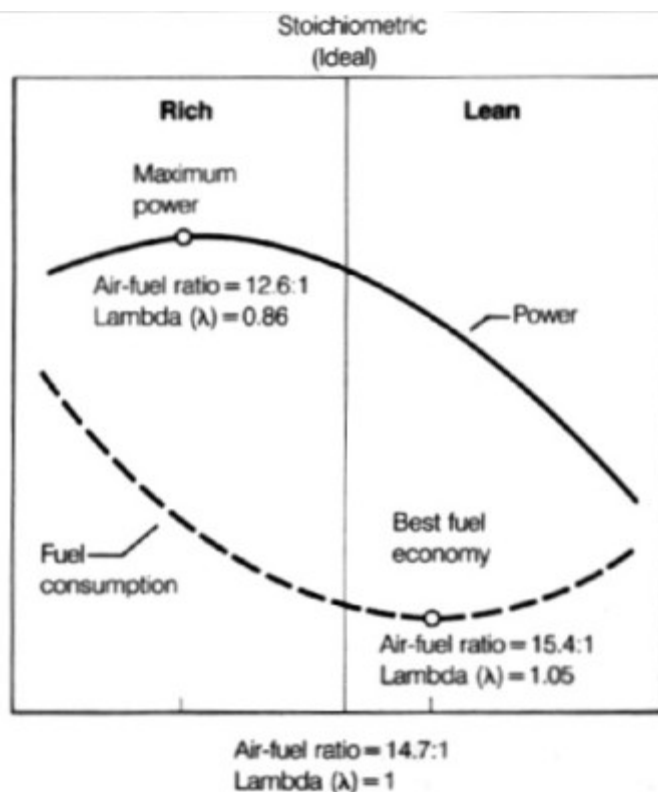

The output of the Lambda O<sub>2</sub> sensor is a voltage as shown in the graph on the above right . So, all we have to do is connect the sensor to a voltmeter and we're set, right? Wrong! The sensor voltage source is high impedance, which means it can't deliver much current or power. This voltage can only be measured accurately after power amplification. Electronic test instruments (which contain power amplification) be used to accurately measure the voltage, but the

inexpensive multimeter may not give an accurate measurement, especially when the sensor is not at operating temperature. The K & N instruments pictured above very probably contain some sort of amplifier in the display device. Another point, the sensor must be very hot (300° C) before it provides a reliable output. The output voltage seems to be relatively independent of the temperature but the power output capability (in this case, current capability) increases as the temperature increases.

Gabriel Pennella ([sarasa911@yahoo.com](mailto:sarasa911@yahoo.com)), the author of the note on the Pelican Parts link above gave me permission to use the graphs above and also sent the data in the table below. Thank you Gabriel! Gabriel has a neat home page at: <http://www.cincado.com/911/>. Check out his James Bond project, quite amusing.

Lambda Factor	Lambda output voltage at 600°C	Exhaust CO	Engine output torque	Observations
0.8	0.95V	7.0%	98.9%	
0.85	0.92V	5.2%	99.9%	Max power = lambda 0.86
0.9	0.88V	3.7%	99.5%	
0.95	0.8V	2.3%	98.7%	
1.00	0.2V	0.9%	96.6%	
1.05	0.08V	0.28%	93.2%	Best fuel economy
1.1	0.068V	0.25%	89.0%	
1.15	0.058V	0.24%	82.0%	
1.2	0.05V	0.24%	74.0%	
1.25+	The mixture will not ignite... Misfiring..			
These numbers are for reference and, will have small deviations, depending on different lambda sensors and engine operating conditions				

Some sensors are equipped with an internal electric heater to get it up to operating temperature quickly. These sensors have two or more wires, one or two for the heater and one or two for the signal. In general, the more wires, the higher the cost. Those sensors with heaters also cost more.

**Fabricate a monitor:** After looking over the Gabriel's and others notes, I decided to build a monitor. I'm an Electrical Engineer so the circuitry holds little mystery. The following describes how I constructed the monitor. This job is well within the capability of one with good eyesight and familiar with electronic components. One reason I chose to go this way is that I have a late TR6 with dual carbs and dual exhaust. I wanted a monitor with dual sensors that could display the A/F situation of both exhausts simultaneously. (Those that chose to purchase an assembled monitor may also find some of the following information useful.)

The first step was to purchase the O2 sensors. I selected the Bosch 11027 single wire sensor obtained from Auto Zone for \$17.99 each. This the cheapest sensor Auto Zone stocks for the '91 Honda Civic. I'm sure it has many other applications. I've done no research on these sensors other than mentioned earlier so I have no idea whether this is a good or poor sensor relative to others. All I can say is that it works. The sensor is shown in the photo below. The

end is threaded 18mm X 1.5 mm. The wire is arranged with a crimp connector. The black tubing over the wire is heat shrink tubing to cover the connector. The electrical signal is measured between the output lead and ground.



**Selecting the sensor location:** Some things to consider when selecting a sensor location:

- Keep it close to the engine so that it heats quickly.
- Don't interfere with other engine components.
- Position the sensor so that sensor can be replaced easily.
- Minimize exhaust gas flow disruption

Probably the best choice is to locate the sensor in the manifold. I thought about drilling holes just above the down pipe flange, pointing one sensor to the front and the other to the rear. This required that I purchase an 18mm X 1.5 mm tap. A quick check of my normal suppliers indicated such a tap costs ~ \$30. Ouch! Besides, I'm not sure the manifold is thick enough to thread properly. Another alternative is to braze on a fixture to hold the sensor. I understand that fixtures (called bungs?) are available. The next choice for me was the down pipe. There is a problem just below the flange; the engine mount restricts the space in front of the pipes and the space behind the pipes must be kept free for starter removal. Also, I didn't want to further obstruct access to the nuts that secure the down pipe flange. I finally settled on mounting the sensors on the under side of the down pipe just below the first bend. Rather than purchasing a fixture, I obtained some 18mm X 1.5 mm nuts to use as a fixture.

Note that an objective of the two sensors is to get a separate measurement for each carb. However, investigation of the exhaust manifold revealed a hole between the two sides just above the flange as shown in the photo on the right. I doubt that there is much crossover unless there is an unbalance in the exhaust pipes and mufflers. Also remember that there is a crossover between the two carbs on the input side so it's impossible to get a completely independent reading of each carb. I did find in later tests that the sensor outputs seemed to reflect the condition of the associated carb, especially at several thousand RPM and higher engine speeds.



**Mounting the Sensors:** The following photos show the installation process. A grinder was

used to shape one side of the nuts to fit the side of the pipes. The thickness of the nuts was also reduced about 0.1 inch. A Unibit step drill was used to drill the pipes. The Unibit makes a nice hole in thin metal. The holes were roughly the same size as the inside diameter of the nuts. The nuts were clamped securely before welding. I used a flux-in-wire welder. When the second nut was welded some splatter managed to get inside the first nut. The next time I do this I'll screw in a bolt to cover the threads before welding.

I used 18 gauge wire to connect the sensor to the display, in this case a blue wire for the front carb and a green wire for the rear carb. Heat shrink tubing was used to cover the splice. The part of the wires in the engine compartment was covered with the same type tubing as used on the wires to the headlights (available from TRF). The cable was routed in front of the engine mount and then along the coolant pipe in the intake manifold and then through the grommet containing the choke cables. Nylon cable ties were used to secure the cable to the coolant pipe.

The lower left photo shows the freshly power coated manifold. The hi temperature paint lasts about two months; I hope the PC lasts much longer.



**Display:** There seems to be two choices for output displays, a analog meter or a LED display. After some experimentation I chose the LED display because it is easier to get a reading with a quick glance and it responds better to transient conditions. Most the articles on the Internet (see links above) suggest using one or two National Semiconductor LM 3914Dot/Bar Display Driver Integrated Circuits. The description of the LM3914 from the National Semiconductor website (<http://www.national.com/pf/LM/LM3914.html>) is:

## General Description

The LM3914 is a monolithic integrated circuit that senses analog voltage levels and drives 10 LEDs, providing a linear analog display. A single pin changes the display from a moving dot to a bar graph. Current drive to the LEDs is regulated and programmable, eliminating the need for resistors. This feature is one that allows operation of the whole system from less than 3V.

The circuit contains its own adjustable reference and accurate 10-step voltage divider. The low-bias-current input buffer accepts signals down to ground, or  $V$ , yet needs no protection against inputs of 35V above or below ground. The buffer drives 10 individual comparators referenced to the precision divider. Indication non-linearity can thus be held typically to  $\pm 1\%$ , even over a wide temperature range.

Versatility was designed into the LM3914 so that controller, visual alarm, and expanded scale functions are easily added on to the display system. The circuit can drive LEDs of many colors, or low-current incandescent lamps. Many LM3914s can be "chained" to form displays of 20 to over 100 segments. Both ends of the voltage divider are externally available so that 2 drivers can be made into a zero-center meter.

The LM3914 is very easy to apply as an analog meter circuit. A 1.2V full-scale meter requires only 1 resistor and a single 3V to 15V supply in addition to the 10 display LEDs. If the 1 resistor is a pot, it becomes the LED brightness control. The simplified block diagram illustrates this extremely simple external circuitry.

When in the dot mode, there is a small amount of overlap or "fade" (about 1 mV) between segments. This assures that at no time will all LEDs be "OFF", and thus any ambiguous display is avoided. Various novel displays are possible.

Much of the display flexibility derives from the fact that all outputs are individual, DC regulated currents. Various effects can be achieved by modulating these currents. The individual outputs can drive a transistor as well as a LED at the same time, so controller functions including "staging" control can be performed. The LM3914 can also act as a programmer, or sequencer.

The LM3914 is rated for operation from 0°C to +70°C. The LM3914N-1 is available in an 18-lead molded (N) package.

The following typical application illustrates adjusting of the reference to a desired value, and proper grounding for accurate operation, and avoiding oscillations.

## Features

- Drives LEDs, LCDs or vacuum fluorescents
- Bar or dot display mode externally selectable by user
- Expandable to displays of 100 steps
- Internal voltage reference from 1.2V to 12V
- Operates with single supply of less than 3V
- Inputs operate down to ground
- Output current programmable from 2 mA to 30 mA
- No multiplex switching or interaction between outputs
- Input withstands  $\pm 35V$  without damage or false outputs
- LED driver outputs are current regulated, open-collectors

- *Outputs can interface with TTL or CMOS logic*
- *The internal 10-step divider is floating and can be referenced to a wide range of voltages*

The good points I see of using the LM3914 are:

- *low-bias-current input buffer* (amplifier) means it won't load down the O2 sensor
- works well on 12V and auto temperature ranges
- it's relatively cheap (~\$3.50)
- easy to make a voltmeter with 0 to 1 volt range.

The next step was to find a suitable display.

Electronic Goldmine

(<http://www.goldmine-elec.com>) had just the thing on Page 42 of their 2001 Spring/Summer Catalog. Their catalog is available online. If you don't find the display on page 42 of a later catalog, look up "display" in the index (I tried LEDs and couldn't find it). The catalog description is shown below. They also carry the LM3914s and the other required parts. The parts used to construct the display are on the right. I cheated a bit, those black things are not actually LM3914s, I didn't have any left so I substituted other integrated circuits that look the same. Unfortunately, I substituted 16 pin devices and the LM3914 has 18 pins. So, the LM3014 looks just like the parts shown except that they're 0.1 inch longer.

### **Multicolor HP Bargraph Display HDSP-4836**

Beautiful 10 segment bargraph features a multicolor display. The first 2 segments are bright red, the next 2 are bright yellow, the next 2 are bright green, the next 2 are bright yellow and the final 2 are bright red. Brand new prime. About 1" long x 3/8"W.

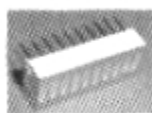

**G9314 \$1.49 ea. • 10/\$14.00**  
**100/\$125.00 • 1000/\$1000.00**

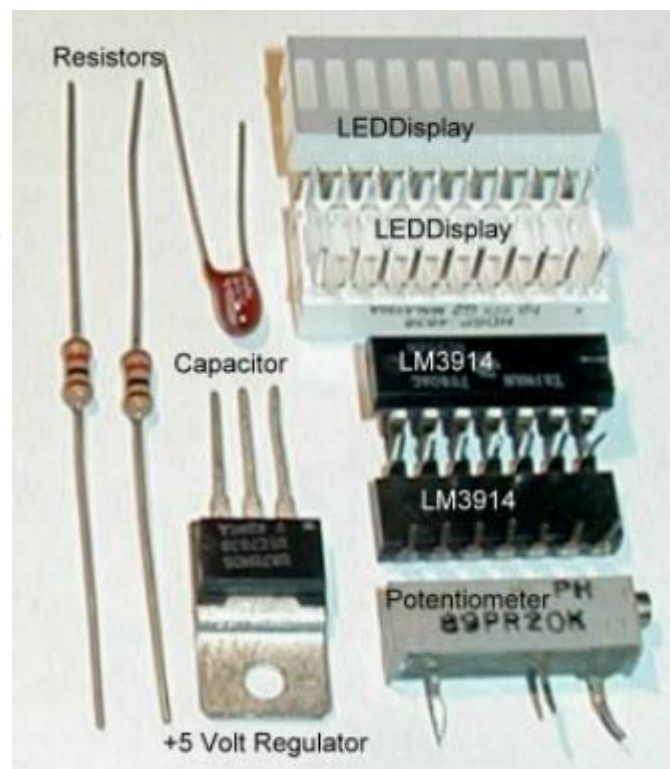

My first display circuit had a linear output; the first LED turned on at 0.09V, the second at 0.18V, the third at 0.27V and the last (tenth) at 0.90V. I used the bar graph mode so that the LEDs turned on at a lower voltage stayed on when additional LEDs were turned on. When the last LED turned on at a voltage greater than 0.9V, all the LEDs were on.

This circuit worked well except all the action took place with nearly all the LEDs on or with very few on. That's not surprising if one looks at the graph above and notes that small changes in A/F near 14 result in a large change in voltage whereas larger A/F changes near the two ends of the graph result in a much smaller voltage change. What was needed was more sensitivity at the two ends and less sensitivity near the middle.

After several design iterations I decided to use two LM3914s for each display but use only half the outputs -- many at the two ends and few towards the middle. The following table shows the design objectives for the relationship of LED, voltage, Lambda, A/F ratio

LED	Voltage Range	Lambda	Air/Fuel Ratio	Output Torque	Observations
	>945mV	<0.80	<12	<98%	Too rich, power loss
	900-945 mV	~0.85	~12.5	100%	Maximum power
	855-900 mV	~0.90	~13.2	99%	Good operation
	810-855 mV	~0.93	13.8	98%	Good operation
	540-810 mV	~0.97	14.3	98%	Good operation
	225-540 mV	~0.98	14.4	97%	Good operation
	180-225 mV	~1.0	14.7	97%	Good operation
	135-180 mV	~1.02	~15	96%	Good operation
	90-135 mV	~1.04	~15.3	95%	Maximum economy
	45-90 mV	1.05-1.25	15.4-18	74-94%	Pretty lean
All out	<45 mV	>1.25	>18	?	Too lean, misfires

The circuit below provides one display for one O2 sensor. I used two sensors so my display has a duplicate display but shared the same 5 volt regular. The regulator is not required but I was afraid the LM3914s might get a little hot when the battery is at 15 volts. The regulator dissipates most the excess power. The regulator also has an internal thermal sensing circuit that limits the current output (if required) to avoid damaging the regulator. The 1 K resistors are 1/4 watt. The filter capacitor value is not critical, a 2.2 or 4.7 uF or more at 10 volts or more is fine. The potentiometer should be adjusted so that there is 0.95 volts on pin 6 of the LM3914 on the right. This will cause the last LED to turn on when the input from the sensor exceeds 0.95 volts.

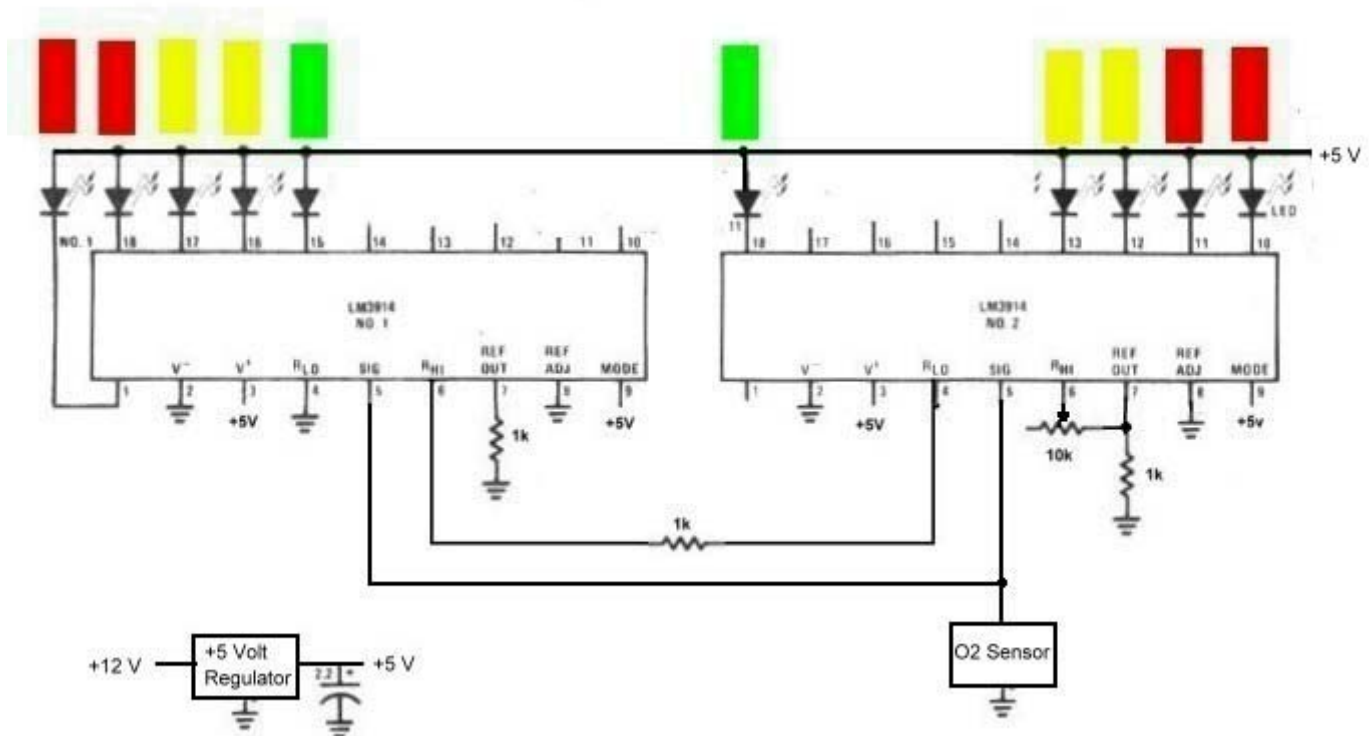

The photos below show the first circuit built. The first step was to cut a length of 1.5" X 1.5" 1/8

inch thick aluminum angle. Next, slots were cut in one side for the two LED displays. An aluminum spacer block was attached to the other side then a short strip of steel was attached on top of the spacer to serve as a clamp. The strip slips over the lower lip on the metal dash to the right of the key lamp and then the hex socket head screw is tightened to secure the monitor. The spacer is the same height as the crash pad so that the front part of the angle is below the crash pad. The metal parts were powder coated before the circuit was constructed. The side where the circuit mounts was masked during the powder coating.

One LM3914 is mounted directly to the LED display as shown in the first photo below. The displays are cemented to the angle with silicon cement. (Note: I connected one of the display segment to +12 V through a 1 K resistor to determine the LED polarity.) The ICs follow the standard IC pin numbering.



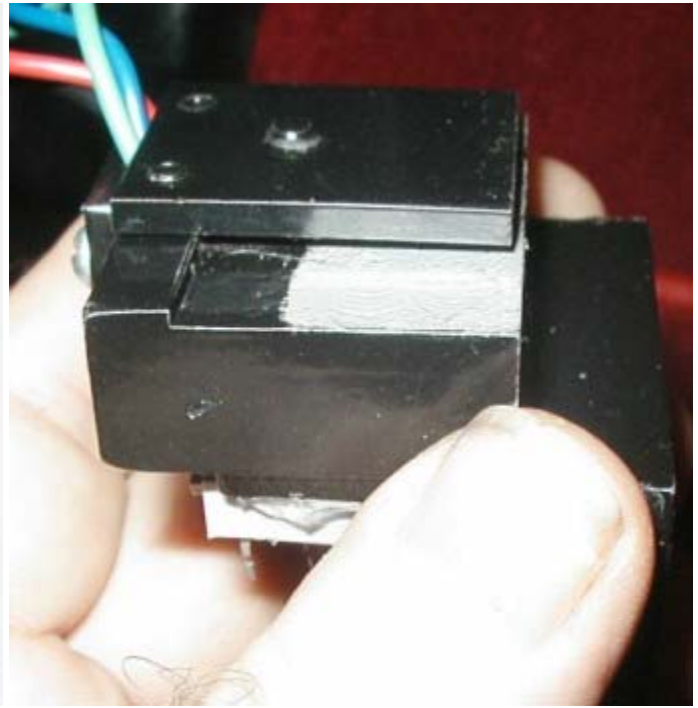
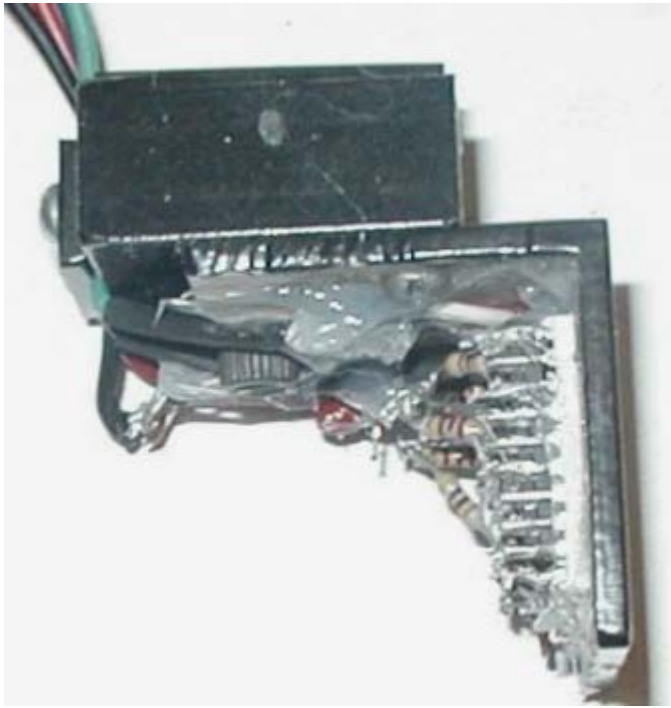

The photo at the right is a close up of the display.

The circuit was subsequently modified by adding a second pair of LM3914s and the two potentiometers as indicated in the schematic above. The added LM3914s were cemented pin side up on each side of the display LEDs. The potentiometers were cement to the other side of the angle beside the clamping screw head. The modified circuit looks a little ratty (left photo below) because of the modifications. If I build another one I'll use a longer piece of angle to give more room for the second pair of LM3914s.

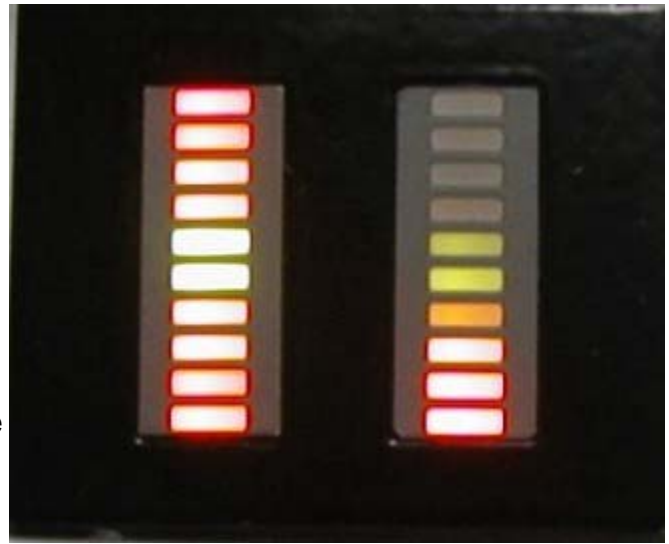



**Troubleshooting the circuit:** The wiring should be checked carefully to minimize troubles. That said, most of us wire things up and then use troubleshooting techniques to find the errors. When power is connected to my display, all LEDs light up, independent of whether the O2 sensor is connected. If the input wire is grounded, the associated LEDs turn off. If the input wire is connected to 1.25V (pin 7 on the ICs) all associated LEDs turn on. If this doesn't happen, check the voltage at the regulator, the IC and the LEDs. If there is +5 volts on pin 3 there should be 1.25 V on pin 7. The potentiometer should be adjusted to so that there is 0.95 volts on pin 6. If some but not all of the LEDs turn on when the input is connected to 1.25 V, then check the individual LED wiring. The voltage on each side of the 1 K resistor connecting pin 4 of one IC and pin 6 of the other IC should be slightly less than 0.5 V.

My display starts to respond after the engine has been running for a few minutes at above idle. All LEDs are on before the sensors start to output power. The ZS carbs are typically set pretty rich at idle so most the LEDs will normally be on at idle. One way to check if the sensors are actually working is to do a short test drive. While traveling in 4th gear at about 1500 rpm, stomp the accelerator to the floor. The mixture should lean momentarily with none or only the lower couple LEDs on and then recover with most the LEDs on. If most the LEDs aren't on at idle, try pulling the choke.

The sensor can be tested with a multimeter. After the engine has been running for 5 to 10 minutes at 2000 rpm or higher, the output should be at least 0.8 volts (measured to ground with a multimeter) with the choke pulled as much as possible without killing the engine. If the sensor voltage is much less than 0.8 volts, then it might be defective. If you suspect the sensor is defective, you might follow some of the sensor testing suggestions found at <http://my.engr.ucdavis.edu/~avsmith/o2sensor.html>.

**Installing the Circuit:** Once the circuit seemed to perform well on the bench I temporarily connected the circuit under the hood and made sure everything seemed to be functioning properly. When the car was first started all the LEDs were on. After a couple minutes the O2 sensors started to generate a signal and the display then reflected the sensor output. The mixture was very rich at idle -- most of the LEDs were on. The engine was revved and it was noted that the mixture leaned as the engine returned to idle. Once everything seemed to be

operating properly, I mounted the monitor below the dash and connected the sensor, power and ground wires.

I used a male bullet connector on the end of the power wire and plugged it into a spare port on the 4 wire female connector sleeve in the green wires next to where the green wires go through the gearbox cover to the gearbox. This is the circuit that powers the reverse lights. This same circuit powers the ignition system. I used a female spade connector on the ground wire. The footwell switch (73 & later TR6) in the center dash support has a ground on one side of the switch. The switch has three terminals. One pair of the terminals are connected together. I make sure the black ground wire is connected to the side of the switch with the double terminals. I then connect the monitor ground wire to the second terminal of the connected pair. The TRs are notorious for grounding problems. I try not to add to these problems --- but am only partially successful

The use of the monitor is describe in a separate note.

**TR250-TR6 Carbs:** [Part I - Disassembly & Theory](#)  
[Part II ? The Overhaul](#)  
[Part III ? Reinstall, Tune and Troubleshooting](#)  
[Powder Coating ZS Carbs](#)  
[Replacing Fixed Needles with Adjustable Needles](#)  
[Air/Fuel Monitor](#)  
[Using Air/Fuel Monitor](#)

[Buckeye TRIUMPHS Technical Page](#)

*hosting donated by*



? 2001 Nelson A Riedel